

!

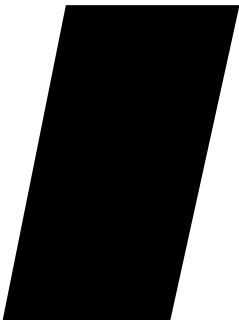

II

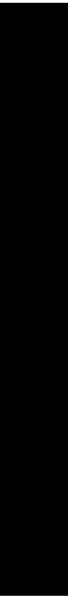

GB/T 4728.6-2000

efghijkl, m
W7》

efghx GB/T 4728
GB/T 4728.6-1984| },ef
19-01 EF。

GB/T 4728.6w fg
f) 大 动 器 (U

GB/T 47

IEC CD

1) IEC(kl, mnop)w Hk, mnop(IEC k nop)+ fg &
 IEC + fw, mA, H, fg+ +kl. +A
 + ,IEC kl fg. kl fg+_n nop. x + ' < ,
 IECK nop fg_m. A IECH +kl & , A & f
 g_m. vkl fg & (ISO) + + / ,IEC A ISO
 2) IECH, + A , +k nop + n
 op _ ,x + O kl +C .
 3) fg, +s kl j, k nop
 * .
 4) kl + C,IEC k nop +k A O  =j IEC
 kl fg+ IECkl fgA| =+k fg fg H > = .
 kl fg IEC 617-6 IEC t 3 nop(/ArsEF)+ 3A u nop(qrj rs
 EF) .
 et 2 A 1983 +t 1 z{ .
 efg+ /;

kl fg (FDIS)	
3A(CO)201 3A/384/FDIS	3A(CO)212 3A/422/RVD

efg+ (+ .
 ` a A, ` a BA ` a C .



728.6—2000
6:1996

**Graphical symbols for diagrams—
Part 6: Production and conversion of electrical energy**

F	r s E F	
0		

" O\$ 1 2

3 12+eTf

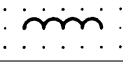
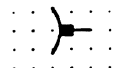
F	r s E F	
06-03-01		u%&+ : O; 78%& %&
06-03-02		%&
06-03-03		%& ƒ %&
06-03-04		, (,] 789 +) + f 4 , . =j 45, EF 06-05-03

4 12+gh

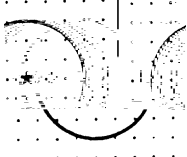
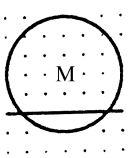
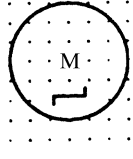
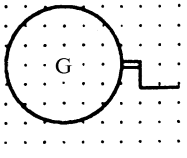
F	r s E F	
06-04-01		, - +CDEF EF' + Fj ƒ C ; C VW? 3- G X, - GS : ; X, - M , - MG O X, - , - j +, - MS : ; , - EF 02-02-03 A 02-02-04, ƒ t 5 t 8 4 VW+, OXY 9 t 16
06-04-02		2 , - ,CDEF
06-04-03		; , - ,CDEF
06-04-04		X, - (,)

5 i j 1 2 k l

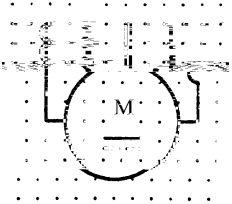
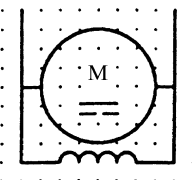
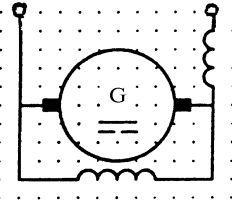
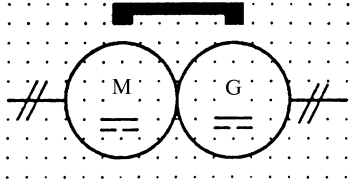
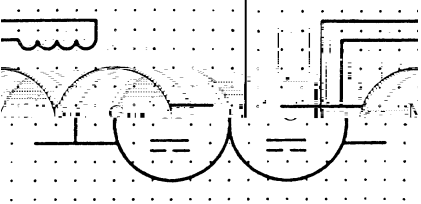
F	r s E F	
06-05-01		23 , -
06-05-02		23 , -
06-05-03		u 23X, -, 4 * A,
06-05-04		GH + 23/23VW? 3-
06-05-05		GH %&+ 23/23VW? 3-

6 m j ; n 6 1 2 k l

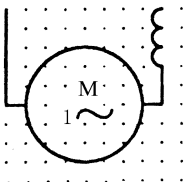
F	r s E F	
06-06-01		, -

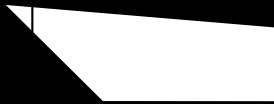

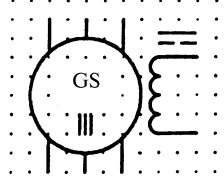
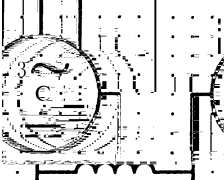
F	r s E F	
06-07-04		%& " + : ; X, -
06-07-05		: ; VW? 3-

8 q r h(s p)1 2 k l

8.1 , - CDEF (06-04-01)j 4W_U () * + > ; , - , 5_W , - . * W_H () *_r = CDEF' j C 4W_U , 45EF 06-08-03.

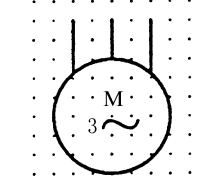
F	r s E F	
06-08-01		< = , -
06-0		

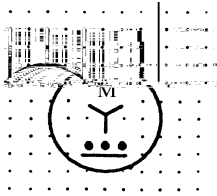
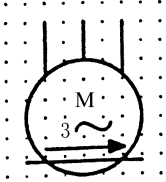
F	r s E F	
06-08-04		HI 9+ s) * +<=, -
06-08-05		C P8 + 2 <=, -

" 3\$ 4567186

1) : O1?@9H EFS :

—s 1:j C 4 %&, 4 j . 1 j ?@9 EF.

—s 2: j EF 04-03-01 4 %&. j : + u : +%&.

2) ?@9 + 4, EF 04-03-01

F	r s E F	
06-09-03		<p>45; 4 , @ + %&?@9 3 %&f + , 3 Y</p>
06-09-04		<p>%&?@9</p>
06-09-05		
06-09-06		<p>I J ? @ 9</p>
06-09-07		
06-09-08		<p>3 , B9</p>

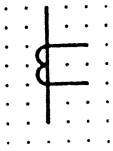
F	r s E F	
06-09-10	s 1 	, 3L < 9 MN? @9
06-09-11	s 2 	

10 uvbc%&+456kl

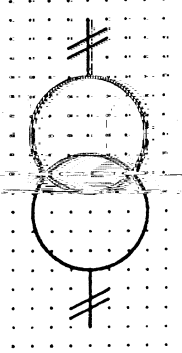
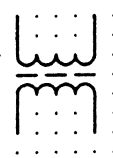
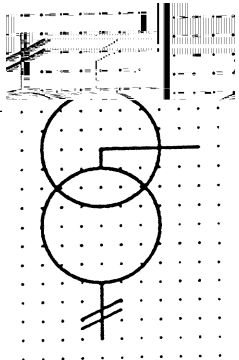
F	r s E F	
06-10-01	s 1 	%& H + %& ? @9
06-10-02	s 2 	
06-10-03	s 1 	C %& H + ? @9

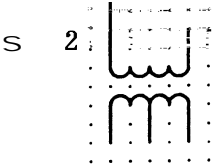
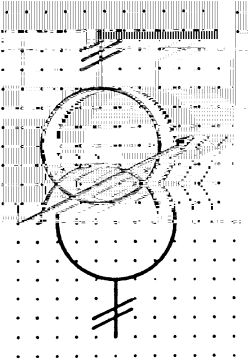
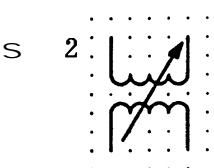
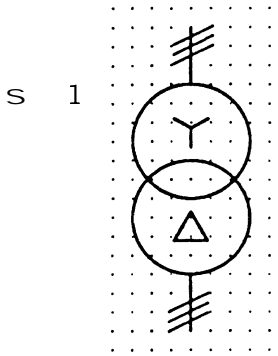
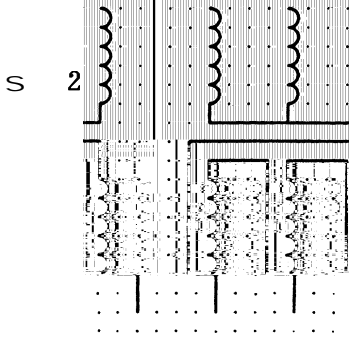

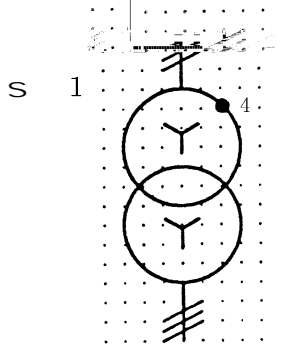
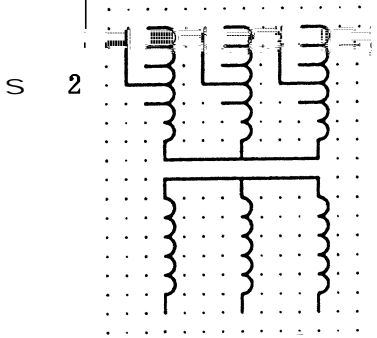
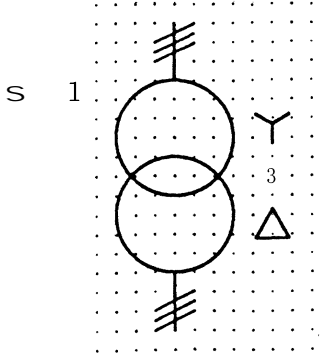
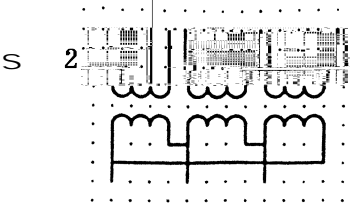
F	r s E F	
06-10-04	<p>s 2</p> 	
06-10-05	<p>s 1</p> 	J ? + ? @ 9
06-10-06	<p>s 2</p> 	
06-10-07	<p>s 1</p> 	s- s) * + ? @ 9
06-10-08	<p>s 2</p> 	

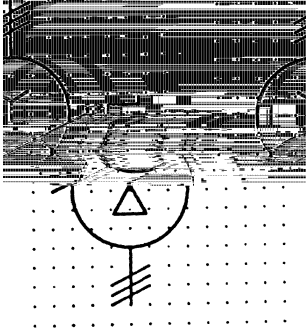
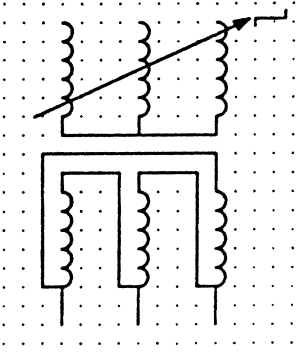
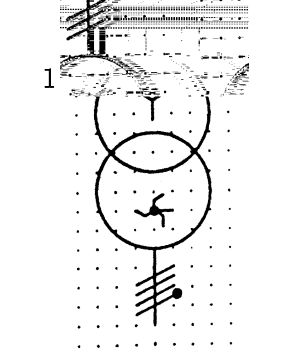
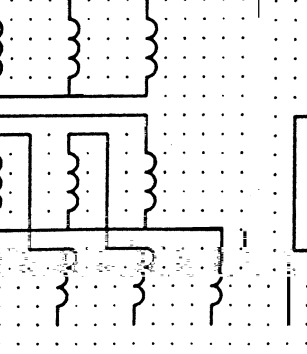
F	r s E F	
06-10-09		<p>GH4 + s- s) * + ? @ 9 % & 4 4 j +) *</p>
06-10-10		
06-10-11		<p> ? @ 9 & + ? @ 9 s- s) *</p>
06-10-12		

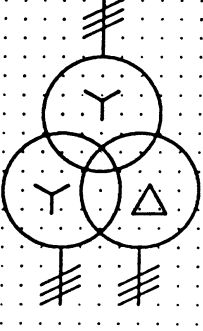
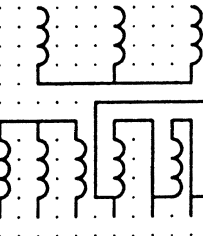
F	r s E F	
06-10-13	<p>S 1</p> 	<p>GHH u*_u + ?@9 S- S) *</p>
06-10-14	<p>S 2</p> 	
06-10-15	<p>S 1</p> 	<p> ?@9 S- S " +) *</p>
06-10-16	<p>S 2</p> 	

F	r s E F	
06-10-17	<p>s 1</p> 	<p> ? @ 9 s - s - s) *</p>
06-10-18	<p>s 2</p> 	

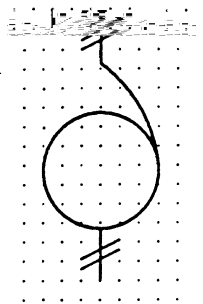
11 wx 456kl

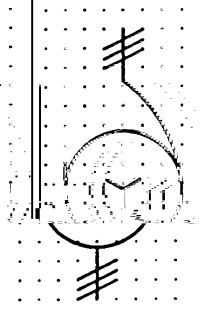
F	r s E F	
06-11-01	<p>s 1</p> 	<p> I J ? @ 9</p>
06-11-02	<p>s 2</p> 	
06-11-03	<p>s 1</p> 	<p> I J ? @ 9 s) *</p>

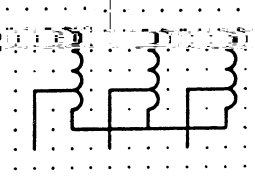
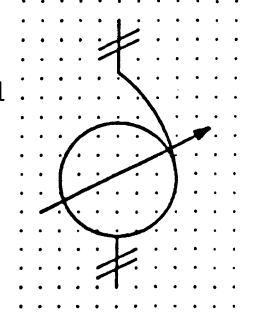
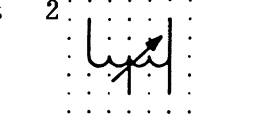
F	r s E F	
06-11-04	<p>s 2</p> 	<p> I J ? @ 9 s) * (s 2)</p>
06-11-05	<p>s 1</p> 	<p>K @ + I J ? @ 9</p>
06-11-06	<p>s 2</p> 	

12 q r y 5 6 k l

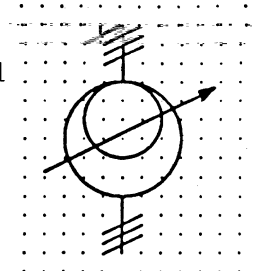
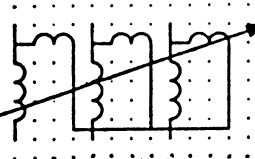
F	r s E F	
06-12-01	<p>s 1</p> 	<p> < = K @ 9</p>
06-12-02	<p>s 2</p> 	

13 z q 6 7 { | 4 5 6 k l

j t 9 + E F 4 L < 9 A M N ? @ 9 .

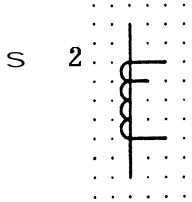
F	r s E F	
06-13-07		C %& C +, 3L < 9(s)

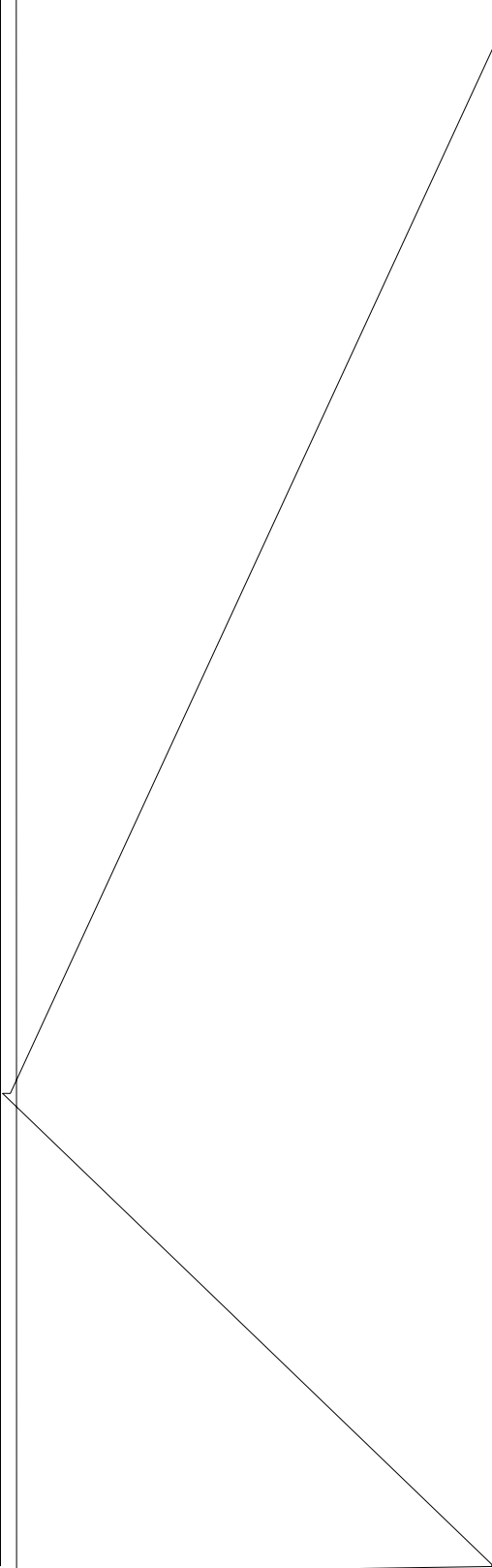

" 9\$ 1: 4; 6

14

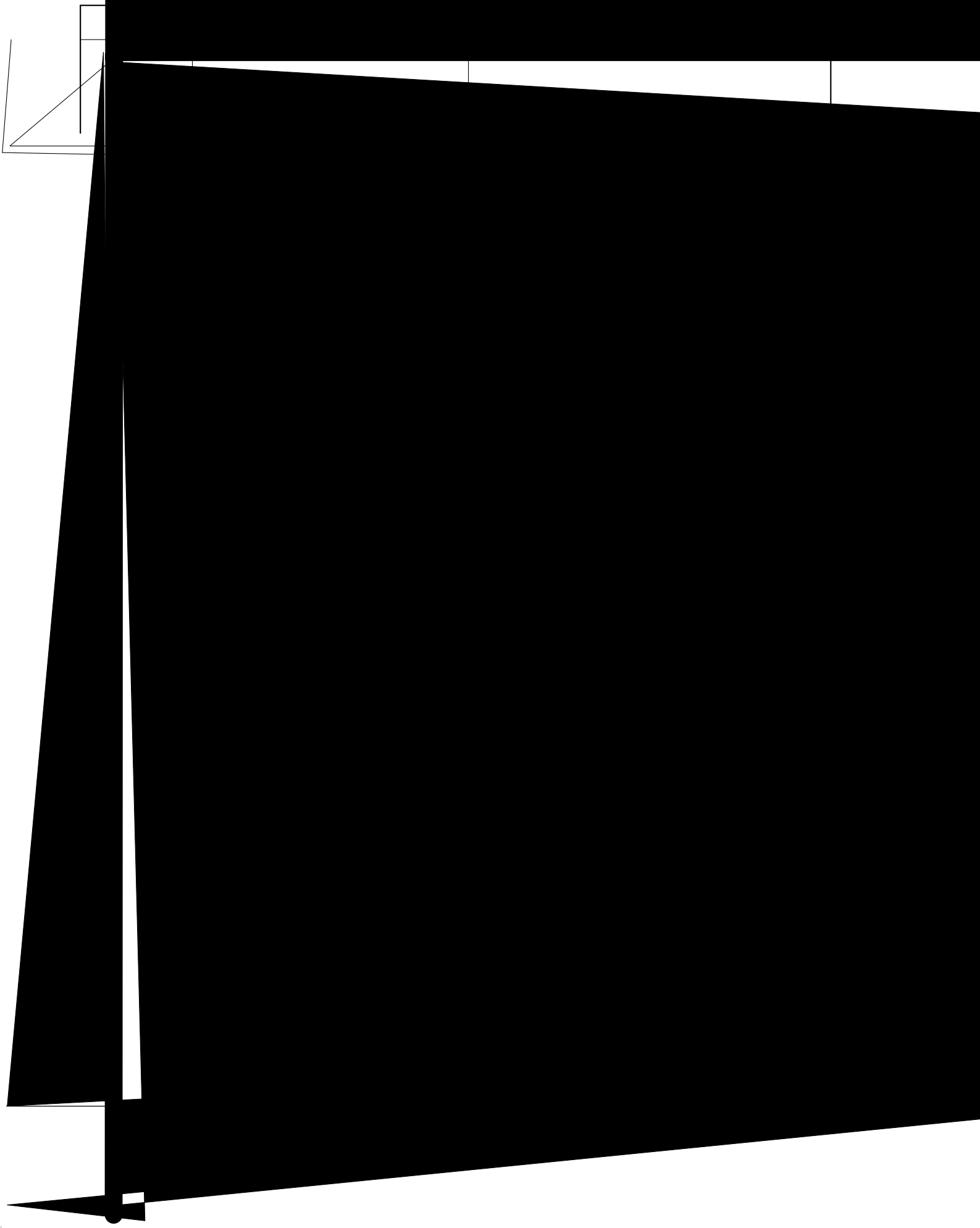

" @\$ 1: AB6

16 • 旋W1: AB6+# t. /

--	--	--

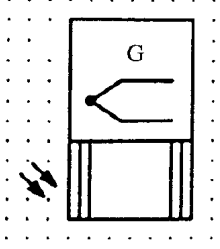
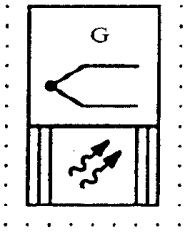
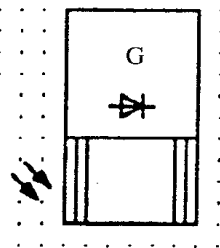
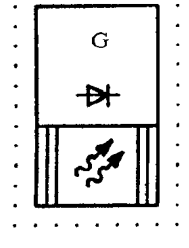
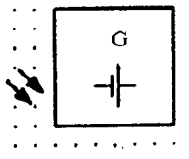
F	r s E F	
06-18-02		j , Z [+Z, XY9
06-18-03		j : Z [+Z, XY9
06-18-04		j , Z [+Z d XY9
06-18-05		j : Z [+Z d XY9
06-18-06		, XY9

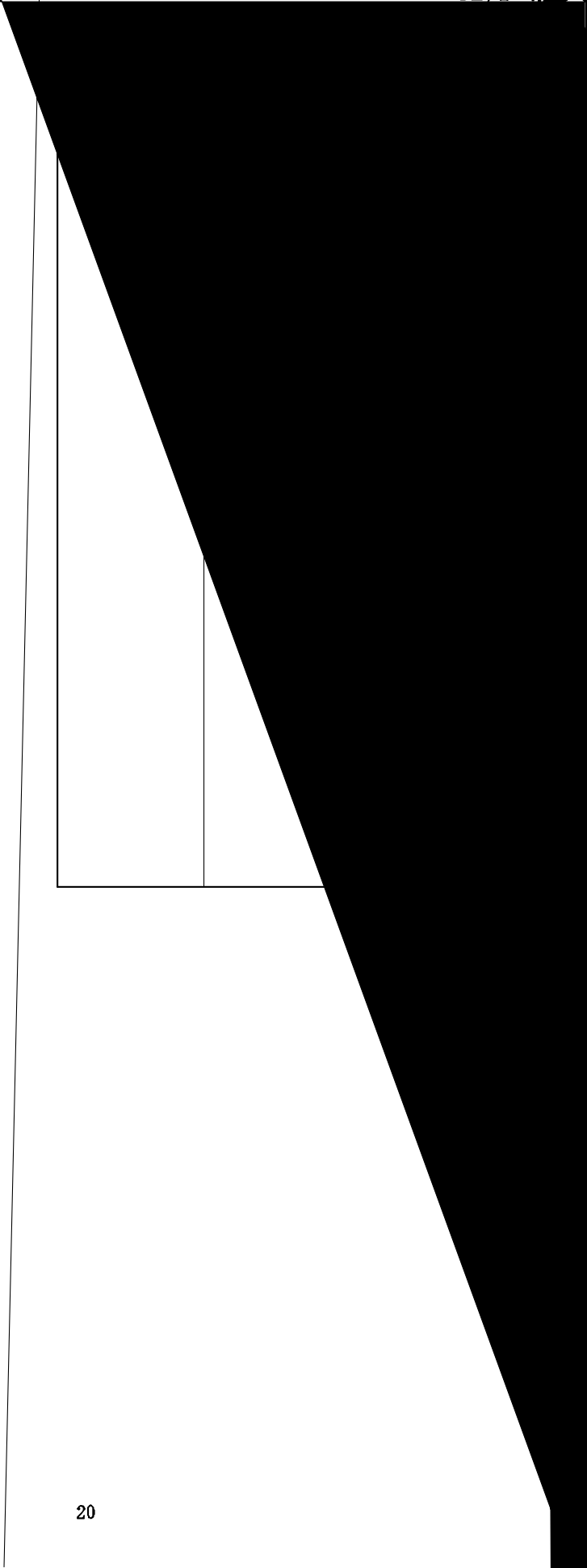

附录 A
(b4+` a)
旧. / (#)



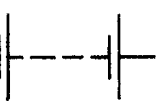

F IEC 617-33 H, GB/T 4728.6—1984 + f g i j , 。
j c r 。
* F+ F GB/T 4728.6—1984 + EF F。)

r E F	
s 	R, S T, S8
s 	

附录
(b4+` a)
(O)

F GB/T 4728.6—1984 + g IEC 617-33 a, , EF 4
C+ 。
* F GB/T 4728.6—1984 + F。)

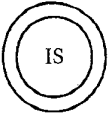

r E F	
	23X, -
	23, -

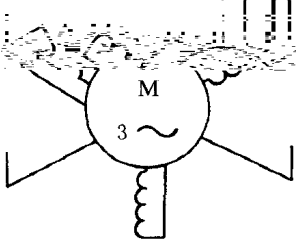
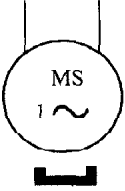
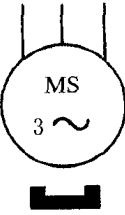
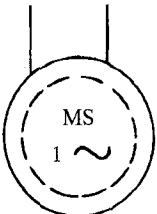
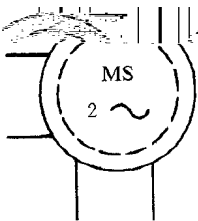
F	r s E F	
06-B4-07 (06-04-08)		23 , -
06-B4-08 (06-04-09)		63 X, -
06-B4-09 (06-04-10)		23 X, -
06-B4-10 (06-04-11)		63 , -
06-B4-11 (06-04-12)		23 , -
06-B4-12 (06-04-13)		< = : ; 9

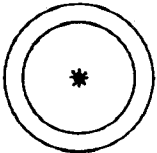
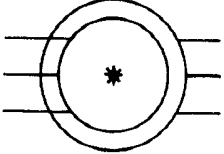
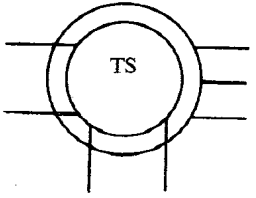
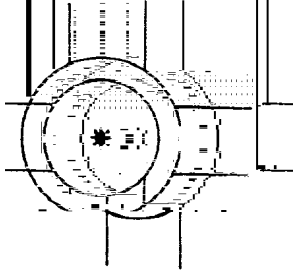
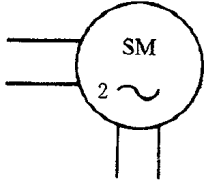
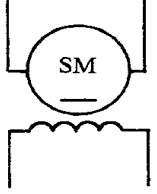
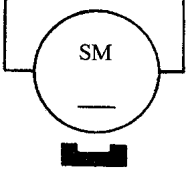

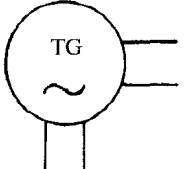
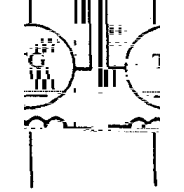
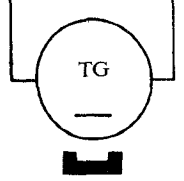
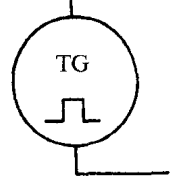
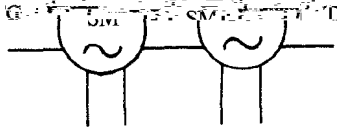
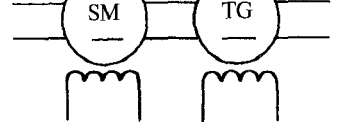
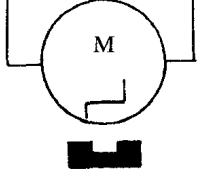
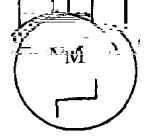
F	r s E F	
06-B6-17 (06-06-04)		63 , -
06-B7-18 (06-07-05)		: ; , -
06-B7-19 (06-07-06)		: ; , -
06-B7-20 (06-07-07)		: ; , -
06-B7-21 (06-07-08)		: ; , -

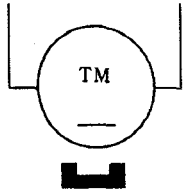
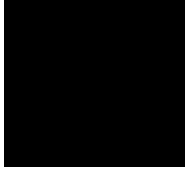
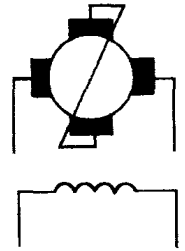
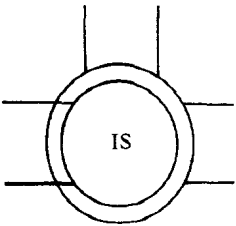
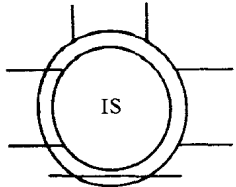
F	r s E F	
<p>06-B10-24 (06-10-01)</p>		<p>I - ,CDEF EF' + F j # : CX ^ _ X - CT ^ _ ? @ 9 TX X - TR * -</p>
<p>06-B10-25 (06-10-02)</p>		<p>EF' + F j # : CDX ^ _ X - TDX X - TDR * -</p>
<p>06-B10-26 (06-10-03)</p>		<p>9</p>
<p>06-B11-27 (06-11-01)</p>		<p>EF' + F j # : R VW? @ 9 (弦 VW? @ 9, VW? @ 9) RX VW? @ 9 X - RT VW? @ 9? @ 9 RDX VW? @ 9 X - Ph <= 9</p>
<p>06-B12-28 (06-12-01)</p>		<p> , -</p>
<p>06-B12-29 (06-12-02)</p>		<p>, 23 , -</p>
<p>06-B12-30 (06-12-03)</p>		<p>23 , -</p>

F	r s E F	
06-B13-31 (06-13-01)		63 X, -
06-B13-32 (06-13-02)		, 23 X, -
06-B13-33 (06-13-03)		23 X, -
06-B13-34 (06-13-04)		MN X, -
06-B14-35 (06-14-01)		63 - &
06-B14-36 (06-14-02)		23 - &
06-B15-37 (06-15-01)		; , -
06-B15-38 (06-15-02)		; , - : x ; , - j 4, n r j 4, O

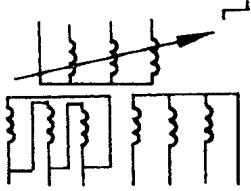
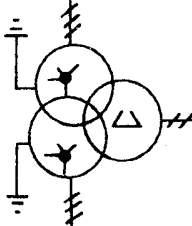
F	r s E F	
06-B16-39 (06-16-01) 06-B16-40 (06-16-02)	 	23 , - 63 , -
06-B17-41 (06-17-01)		, - 扩 -
06-B18-42 (06-18-01) 06-B18-43 (06-18-02)	 	$\leq ; 9$ $2 \leq ; 9$
06-B19-44 (06-19-01) 06-B19-45 (06-19-		芯

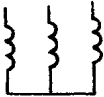
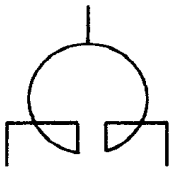
F	r s E F	
06-B20-47 (06-20-20)		
06-B20-48 (06-20-21)		

F	r s E F	
<p>06-B24-54 (06-24-01)</p>		<p>频 ? 阻 9</p>
<p>06-B24-55 (06-24-02)</p>		<p>u 裂, B 9</p>
<p>06-B26-56 (06-24-04)</p>		<p>+R, S & T, S &</p>